



SERCO LOADWARRIOR® Dock Lifts and Ergonomic Lift Tables

Serco LOADWARRIOR Lift Products help increase productivity and employee safety with innovative, cost effective solutions to the unique challenges associated with moving products in the plant and on the dock.

SERCO® LOADWARRIOR® HYDRAULIC DOCK LIFT:

THE SAFE, EFFICIENT SOLUTION FOR RESTRICTED SPACES.

Serco® LOADWARRIOR Hydraulic Dock Lifts make product handling and loading operations more efficient in applications where space is restricted. Dock lifts are a cost effective alternative to space-consuming concrete ramps and can accommodate a wide variety of truck sizes and styles from pickups to standard semi-trailers and more. LOADWARRIOR Dock Lifts can be pit or surface-mounted inside the building or in front of the loading dock for optimal versatility.



Handheld control



Remote mounted power unit includes oil and hoses

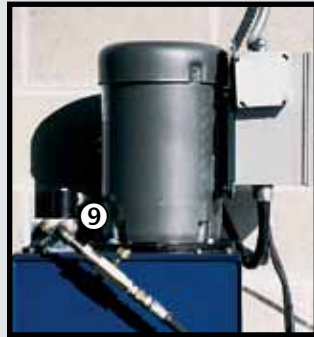

Available in 4,000-40,000 lb. (1,814-18,144 kg) Capacities

- ① Removable mandrel-formed tubing handrails (for shipping purposes)
- ② Beveled toe guards (for pit mounted applications)
- ③ Dual hydraulic lifting cylinders for optimum performance
- ④ Upper travel limit switch (not shown)
- ⑤ Maintenance safety device (not shown)
- ⑥ Dual safety chains across operating ends
- ⑦ 18" standard solid or split bridge plate
- ⑧ Velocity fuses on lift cylinders prevent uncontrolled descent
- ⑨ Manual lowering valve lowers the lift in the event of power loss

SERCO® LEVEL-LIFT:

UNMATCHED PERFORMANCE, VERSATILITY AND EFFICIENCY.

The Serco Level-Lift combines the speed and efficiency of a hydraulic dock leveler with the versatility of a scissors lift to eliminate the need for dedicated dock equipped with expensive concrete ramps. The Level-Lift can service almost any style of trailer or van from grade-level to 59" (1,499 cm) above grade.

HIGH PERFORMANCE DOCK LEVELER



The Serco Level-Lift provides the same performance benefits as a hydraulic dock leveler such as regenerative hydraulics, powered lip control, safety velocity fuse and push-button controls.

SCISSORS LIFT VERSATILITY



Unlike standard scissors lifts, the Serco Level-Lift's hydraulically powered dock lip ensures faster cycling times. With up to 20,000 lb. (9,072 kg) lifting capacity the Level-Lift can handle the toughest loads while also providing dock-to-grade level forklift access.

- ① Full range telescoping toe guards
- ② Protective front weatherguard
- ③ Dual Integral leveler maintenance struts
- ④ Velocity fuses on leveler and lift prevent uncontrolled descent
- * Independent hydraulic systems for leveler and lift
- ⑤ Up to 20,000 lb. (9,072 kg) scissors lift
- ⑥ Quick-Connect style electrical cables make installation simple, fast and less expensive. (not shown)

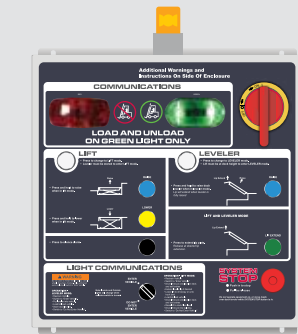
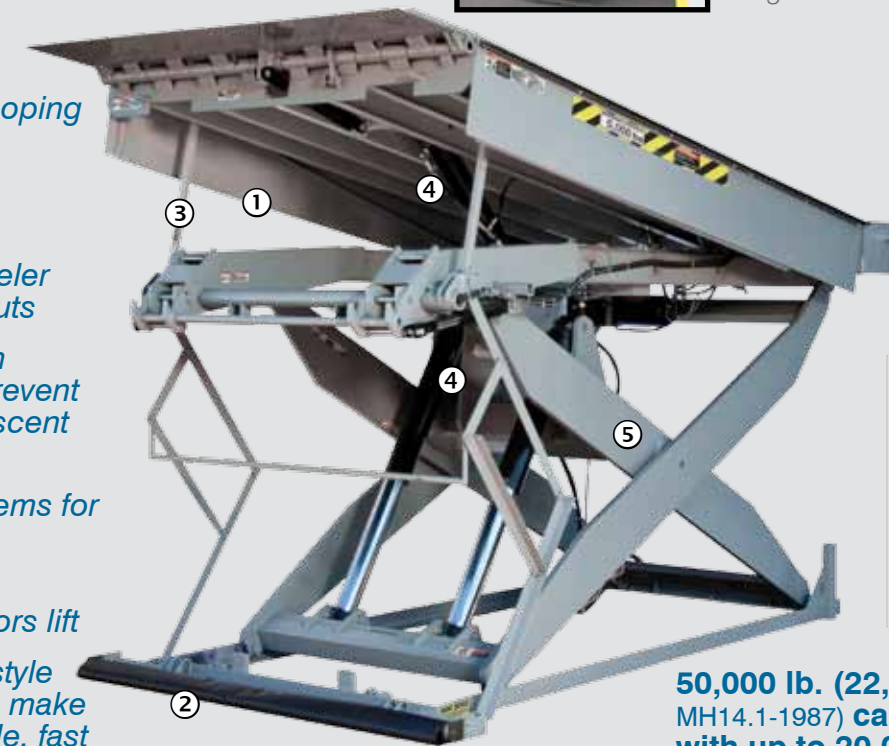

50,000 lb. (22,680 kg) (per ANSI MH14.1-1987) capacity leveler with up to 20,000 lb. (9,072 kg) capacity scissors lift

DOCK APPLICATIONS:

The LOADWARRIOR HYDRAULIC DOCK LIFT increases productivity, safety and efficiency by allowing you to load and unload with ease in a variety of dock applications.

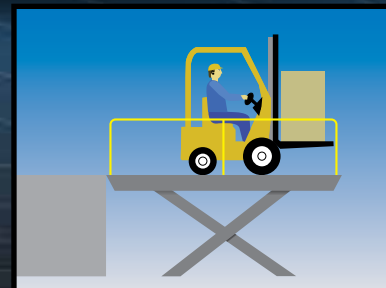

Standard Dock (42-48", 1-1.2 m high)

The LOADWARRIOR Hydraulic Dock Lift is a powered loading dock for moving equipment or material to ground level.

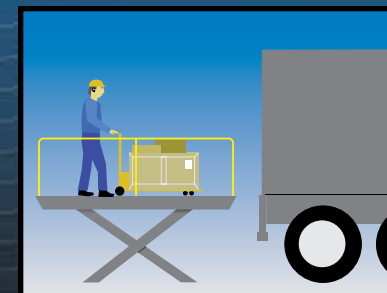

No Dock (ground-level buildings)

The LOADWARRIOR Hydraulic Dock Lift serves as a dock for loading and unloading operations.

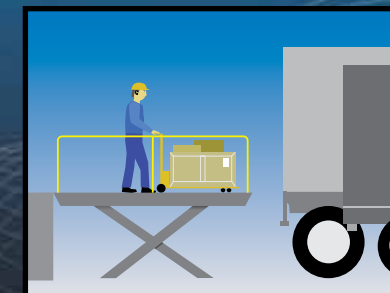

Various Truck bed Heights (20-60", 0.5-1.5 m high)

The LOADWARRIOR Hydraulic Dock Lift brings to dock to the trailer, regardless of height.

SERCO® LOADWARRIOR® RAIL LIFT: LIFTING WORKER PRODUCTIVITY AND SAFETY TO NEW HEIGHTS.

Serco LOADWARRIOR RAIL LIFTS are an efficient loading dock solution when a powered, surface mounted lift is required. LOADWARRIOR Rail Lifts are quick, easy and inexpensive to install. They come standard with a 4 ½" (114 cm) lowered height and are completely self-contained making relocation simple.

- ① 18" (457 cm) long hinged bridge
- ② Low-profile ramp
- ③ Checker plate or smooth deck surface
- ④ 42" (1,067 cm) high fixed handrail
- ⑤ Direct-thrust cylinder provides constant speed through full range of travel
- ⑥ Velocity fuse on lift cylinder prevents uncontrolled descent
- ⑦ NEMA 4X handheld push button
- ⑧ 60" (1.5 m) high fixed mast guard
- ⑨ Sealed guide bearing rollers



*Bollard not included

Available in
4,000 or 6,000 lb.
(1,814 or 2,722 kg)
capacities

Serco Rail Lifts provide a versatile, cost effective solution to move people and products on the loading dock where space is limited and a surface mounted lift is required. Rail Lifts can accommodate a variety of vehicle sizes as well as ground level loading for superior efficiency and increased productivity.

SERCO® TRUCK LEVELERS: THE SOLUTION FOR HIGH-CUBE, LOW BOY AND AIR-RIDE SUSPENSION TRAILERS.

THE SOLUTION FOR HIGH-CUBE, LOW BOY AND AIR-RIDE SUSPENSION TRAILERS.

Longer and lower trailers present new challenges for loading dock operators. Serco Truck Levelers are used in applications where a dock is too high or low to service trailers with conventional dock levelers. Truck levelers reduce the ramp angle to the back of the trailer by safely raising or lowering the trailer to match the height of the loading dock. Making loading operations safer, especially in wet, icy or inclement weather conditions.

- Surface or pit mount
- Compatible with any size truck or trailer
- Beveled toe guards
- 24" travel standard. Available in 36" travel
- Cannot be released from outside the building
- Interior/Exterior LED red and green lights for positive communication
- Heavy "I" beam structural support
- Synchronized cylinders with velocity fuses
- 14', 16', 18' and 20' platform lengths available
- 60,000 lb. capacity
- Available with optional Universal Truck-Chock™ wheel restraint system



Standard push-button control panel

When the added safety of an automated wheel restraint is required, the Serco Universal Truck-Chock™ Truck Leveler system effectively secures trailers. Even those with missing or damaged rear impact guards. The system includes inside and outside light displays for positive communication between dock worker and truck driver.



Serco Truck Levelers are available in surface-mounted or pit-mounted designs



*In most applications, Universal Truck-Chock will engage only one tire.

SERCO® LOADWARRIOR® IN-PLANT LIFTS

Manual Turntables:

Serco LOADWARRIOR Turntables are easy to install and allow employees to rotate their work to them rather than walking around it to reduce reaching, bending and twisting to easily enhancing both ergonomic and labor-saving benefits. A Serco LOADWARRIOR Turntable is great for just about any application. Manual turntables are available in up to 6,000 lb. capacities and powered turntables are available in up to 10,000 lb. capacities. .

Design Highlights:

- Rigid base with pre-drilled mounting holes
- ½" thick steel platform with rounded corners
- Rollers are sealed ball bearings for ease of operation
- Roller pin bushing are self-lubricating
- 1 HP, 115-230V/60hz/1ph motor
- For higher capacities and higher travel consult factory



Tilters:

Small parts and components are typically stored in bins and baskets that can be difficult to access. Serco LOADWARRIOR Tilters position parts and hard to reach objects within easy access of employees to minimize stretching and bending, reducing the risk of back injuries. LOADWARRIOR Tilters are available in 2,500 to 10,000 lb. capacities with 30 to 45 degrees travel and are the perfect choice for tilting products and ergonomic product positioning.

Design Highlights:

- Pre-wired power unit with UL-approved control components
- Power unit internally mounted
- Available in 1 HP single-phase and 3 phase power
- Self-lubricating bearings
- Single wire braided hydraulic hoses
- For higher capacities and higher travel consult factory



Scissor Lift Tables:

Serco® LOADWARRIOR Scissor Lift Tables provide versatile, ergonomic and safe lifting solutions for virtually any material handling application. By bringing the work to the employee, lift tables not only increase a facility's productivity, they reduce employee fatigue and dramatically decrease the risk of serious back injuries. Available in up to 10,000 lb. capacities with 24" to 60" travel.

Design Highlights:

- Pre-wired power unit with UL-approved control components
- Power unit internally mounted
- 1 HP electric single and three-phase motor
- Self-lubricating bearings
- Solid steel legs with stiffener bars
- Single wire braided hydraulic hoses
- For higher capacities and higher travel consult factory



Double Scissor:

Serco LOADWARRIOR Double Scissor Lifts provide operators with a high height adjustable work platform without utilizing valuable floor space. The Double Scissor Lift has the same size platform as the standard lift and are generally used for palletizing and de-palletizing loads, feeding and receiving products and ergonomic positioning for maximum employee comfort. Available in up to 10,000 lb. capacities with 60" to 90" travel, LOADWARRIOR Double Scissor Lifts are an economic option when space is limited.

Design Highlights:

- Pre-wired power unit with UL-approved control components
- Internal power unit, consult factory
- 1 HP single and three-phase motor
- Self-lubricating bearings
- Solid steel legs with stiffener bars
- Double wire braided hydraulic hoses
- For higher capacities and higher travel consult factory



Zero Lift Table:

Serco LOADWARRIOR Zero Lift Tables are designed to lift materials to an ergonomic working height increasing employee safety and productivity. This surface-mounted lift lowers flat to the floor so a cost effective pallet jack can be used to load and unload these 2,000 and 4,000 lb. capacity lifts. The Serco LOADWARRIOR Zero Lift is a factory wired, 115V single phase application making it a great energy saving option to expensive fork lifts.

Design Highlights:

- 1 HP Power Unit - 115v/1ph/60hz with 115 Volt
- Controls x 10' of Hose
- Power Unit with UL Approved Electrical Panel
- Push Button Control - NEMA 4X with 10' of Cable
- Self-Lubricating Bushings with Hardened Chrome Pins for Pivot Points
- Velocity fuses on cylinders to prevent uncontrolled Descent
- Up Travel Limit Switch
- Maintenance Blocks
- Optional 304 stainless steel for food grade applications
- For higher capacities and higher travel consult factory

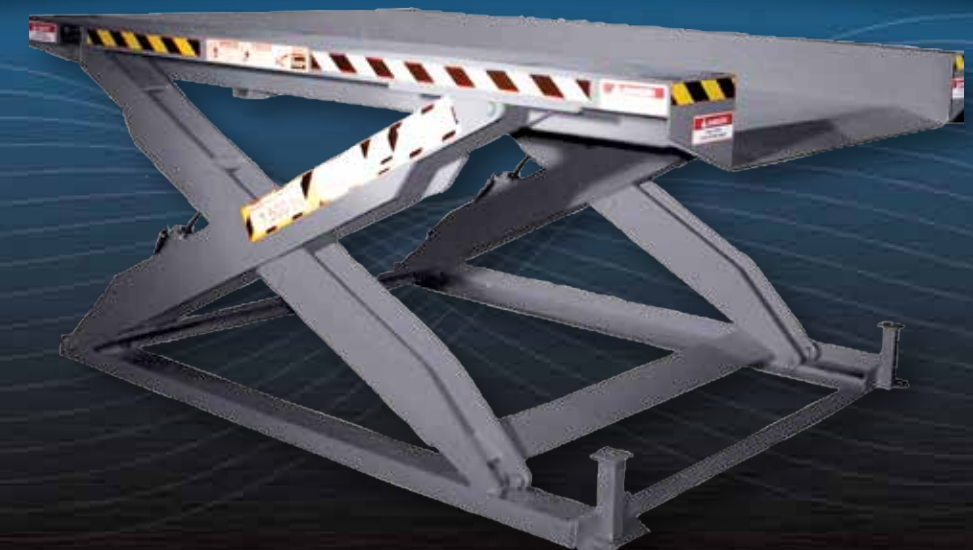

SERCO® TAILORED LIFT PRODUCTS SOLUTIONS

INNOVATIVE, COST EFFECTIVE SOLUTIONS FOR UNIQUE APPLICATIONS.

Many air freight carriers experience significant forklift damage to both freight and material handling equipment.

Serco LOADWARRIOR® Hydraulic Cargo Lifts improve efficiency and make the workplace safer for employees moving airline cargo. Ball transfers or inverted casters and mechanical stops built into the lift allow cargo to be ergonomically moved from the truck, to the warehouse and onto the plane, eliminating forklift use while also reducing employee injuries and freight damage. Available in a variety of sizes and capacities to fit nearly every tailored application.



EXPERIENCE OUR ENGINEERED SOLUTIONS FOR YOURSELF



For nearly 60 years, Serco has been designing, manufacturing and integrating loading dock equipment. We invite you to view our full line of loading dock and warehouse products at our modern showroom in Dallas, Texas. Our Visit-in-Person (VIP) program offers a unique opportunity to gain hands-on experience with our products and interact with engineering and manufacturing personnel in a comfortable environment.

CAN'T MAKE THE TRIP TO DALLAS? Let our Mobile Showroom come to you. Our 53' completely enclosed and temperature controlled trailer features over 20 full-sized, fully-functional dock equipment demo units. Call 1-877-778-DOCK (3625) to schedule an appointment and we'll drive our loading dock solutions straight to your door.



1612 Hutton Dr., Suite 140
Carrollton, TX 75006

Tel: 800.933.4834
Fax: 972.323.2639

email: sales@sercocompany.com
www.sercocompany.com



A continuing research program is in effect at Serco. We reserve the right to incorporate product improvement at any time without prior notice.