

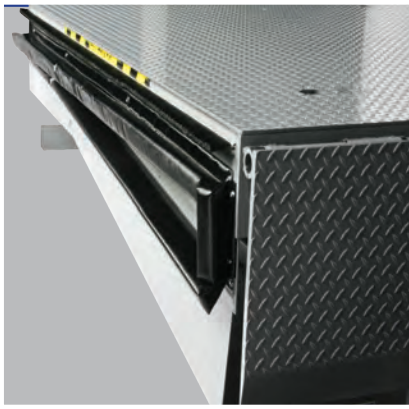

Warehouse & Loading Dock Solutions



APS Resource®

Your Aftermarket Solution

WHO WE ARE

FOR OVER 20 YEARS, APS RESOURCE HAS BEEN THE LEADING SUPPLIER OF DOCK EQUIPMENT REPLACEMENT PARTS AND WAREHOUSE SAFETY EQUIPMENT FOR YOUR BUSY FACILITIES. APS RESOURCE IS DEDICATED TO PROVIDING YOU WITH HIGH QUALITY EQUIPMENT, REDUCING YOUR FACILITY'S DOWNTIME, AND HELPING YOU PRESERVE THE SIGNIFICANT FINANCIAL INVESTMENT THAT YOU HAVE MADE IN YOUR LOADING DOCK AND WAREHOUSE EQUIPMENT.

APS RESOURCE'S COMPREHENSIVE OFFERINGS INCLUDE ENERGY SAVING SYSTEMS, LED DOCK LIGHTS, SPECIALTY DOOR PANELS, GATES AND BARRIERS, PROTECTIVE SYSTEMS, AND PRODUCT UPGRADES. OUR PRODUCTS ARE SOLD THROUGH AN EXTENSIVE NETWORK OF TRAINED DISTRIBUTORS WHO PROVIDE SUPERIOR INSTALLATION AND SERVICE.



TABLE OF CONTENTS

Vehicle Restraints	4	APS&GO-LED	18
<u>APS 2000</u>	<u>4</u>	<u>Heavy-Duty Adjustable Fan/Light</u>	<u>19</u>
<u>S.W.A.T. Secondary Warning Alert Technology</u>	<u>5</u>	<u>E-Saver LED Lamps</u>	<u>19</u>
Gates & Barriers	6	Warehouse Fans	20
<u>Dock Impact Barrier</u>	<u>6</u>	<u>Turbo-ES Fans</u>	<u>20</u>
<u>Dock Impact Barrier-LC</u>	<u>7</u>	<u>Dock Light/Fan Combination</u>	<u>20</u>
<u>DUAL CHAIN</u>	<u>8</u>	Protective Systems	21
<u>Work Safe Gate</u>	<u>9</u>	<u>Dock Defender</u>	<u>21</u>
Energy Saving Products	10	<u>Bumpers</u>	<u>21</u>
<u>Energy Guard Retrofit Kits</u>	<u>10</u>	<u>Slider Rail</u>	<u>21</u>
<u>Dock Leveler Weatherseal</u>	<u>10</u>	<u>Sentry-Rail</u>	<u>22</u>
<u>Door Weatherseal</u>	<u>11</u>	<u>Sentry-Rail-LT</u>	<u>22</u>
<u>WeatherWall</u>	<u>11</u>	<u>Impact-A-Track Reflect</u>	<u>23</u>
<u>Edge Sealr</u>	<u>11</u>	<u>Trak-Sentry</u>	<u>23</u>
<u>Dock Stufr</u>	<u>11</u>	<u>Z-Guard</u>	<u>23</u>
<u>Door Sprag</u>	<u>11</u>	<u>Column Protectors</u>	<u>24</u>
FLEX-BACK Panel	12	<u>Fork Sentry</u>	<u>24</u>
<u>FLEX-BACK Door Panel</u>	<u>12</u>	<u>End of Rack Protectors</u>	<u>25</u>
Security Gates	12	<u>Rack Post Protectors</u>	<u>25</u>
<u>Security Gate</u>	<u>12</u>	<u>Drain Pipe Protectors</u>	<u>25</u>
<u>Envirogate LT</u>	<u>12</u>	<u>Bollards & Bollard Covers</u>	<u>25</u>
Product Upgrades	13	Safety Products	26
<u>LED Light Upgrades</u>	<u>13</u>	<u>Trailer Stabilizers</u>	<u>26</u>
<u>ATC - Air Conversion Kit</u>	<u>13</u>	<u>Visual Barriers</u>	<u>26</u>
<u>HTC - Hydraulic Conversion Kit</u>	<u>13</u>	<u>Wheel Chocks & Chains</u>	<u>27</u>
Tactical Series	14	<u>Wheel Guides</u>	<u>27</u>
<u>Impact-A-Track LED</u>	<u>14</u>	APS Resource's Comprehensive Lineup	28
<u>Tactical LED Dock Light</u>	<u>15</u>		
Dock Lighting	15		
<u>High Impact LED Dock Light</u>	<u>16</u>		
<u>G-Flex LED Dock Light</u>	<u>17</u>		
<u>Dock Strobe</u>	<u>18</u>		
<u>Reflect and Guide Stripes</u>	<u>18</u>		
<u>LED Guide Lights</u>	<u>18</u>		

APS 2000®

The APS 2000® is a superior rotating hook, impact-style vehicle restraint developed specifically to reduce the occurrence of accidents at the dock. The APS 2000 combines an advanced LED communication system with a low profile restraint carriage.



PLC-based control panel with red/green composite light



Low-Profile 6" x 6" Heavy-Duty Industrial Light Box



Universal Red and Green LED Lights/Symbols

Features:

- IP67S rated motor with electro-mechanical brake; no adjustment needed
- Zinc plated/yellow dichromate finish for superior corrosion resistance
- LED internal/external light and sign communication

Benefits:

- Restraint can withstand 32,000lbs. of force
- Automatic re-engagement
- Low profile, 9" carriage has a service range of 9"-25" off grade

Vehicle Restraint

Causes of dock accidents:



Early truck departure is the result of miscommunication between truck driver and forklift operator resulting in the truck leaving the dock prematurely.



Constant impact of start/stop action of a fully loaded forklift can cause the trailer to creep forward inch by inch, beyond the reach of the leveler lip, causing the leveler to slip off the back of the trailer and to drop suddenly.



The inertia of the forklift in the front of the unsupported trailer causes the landing gear to collapse or the trailer to up-end.

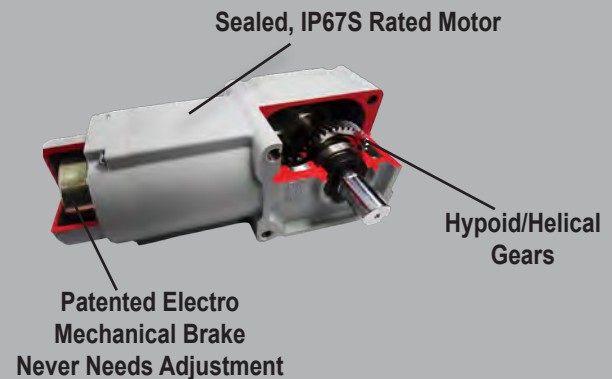
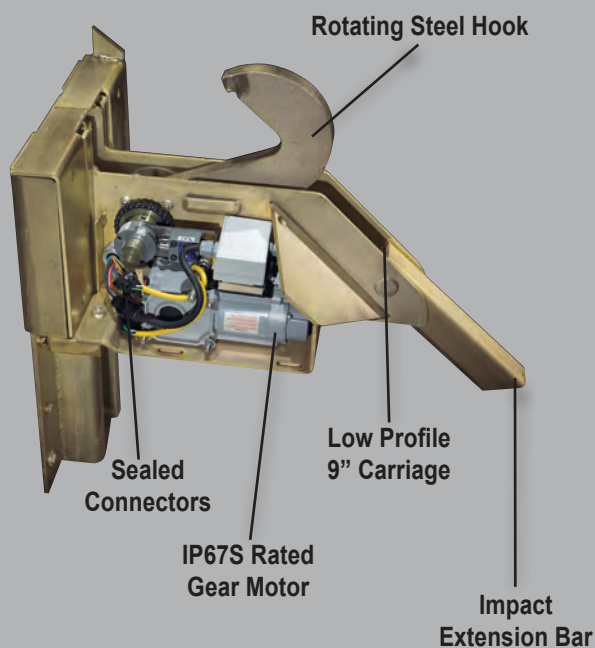

S.W.A.T- Secondary Warning Alert Technology



- The S.W.A.T. module flashes the loading dock light when the restraint faults to indicate a change in dock status
- Works with most restraints that have an alarm or warning state
- Flash rate of 60 fpm
- LED light to indicate receptacle output status
- Compatible with many dock lights (consult owners manual)

Dock Impact Barrier™

The Dock Impact Barrier can reduce the occurrence of accidents due to fork lift, pallet jack or pedestrians falling off the dock when the door is open.

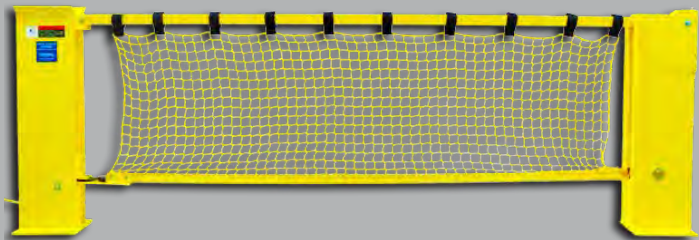

Door Size	Overhead Clearance
6'	10'4"
7'	11'4"
8'	12'4"
9'	13'4"
10'	14'4"

Features:

- Stops a 10,000 lb. gross load at 4 mph
- 42" top rail meets OSHA standard for withstanding 200 lbs. of force from any direction
- High visibility yellow

Benefits:

- OSHA compliant
- Interlock capable
- Protects overhead doors & tracks
- Gas spring assisted for easy, one-handed operation

Dock Impact Barrier LC™

While still meeting limited overhead clearance requirements, the Dock Impact Barrier LC can reduce the occurrence of accidents due to fork lift, pallet jack or pedestrians falling off the dock when the door is open.



Door Size	Overhead Clearance
8'	9'10"
9'	10'10"
10'	11'10"

Features:

- Stops a 10,000 lb. gross load at 4 mph
- 42" top rail
- High visibility yellow with safety striping on the rails of the non-netting version
- Optional netting and Retrofit Kits available for OSHA Compliance

Benefits:

- OSHA compliant
- Interlock capable
- Good for low ceilings
- Overhead clearance reduced by 30"
- Protects overhead doors & tracks
- Gas spring assisted for easy, one-handed operation

DUAL CHAIN™

The DUAL CHAIN is a set of strengthened security chains used to help protect workers from edge of dock accidents.

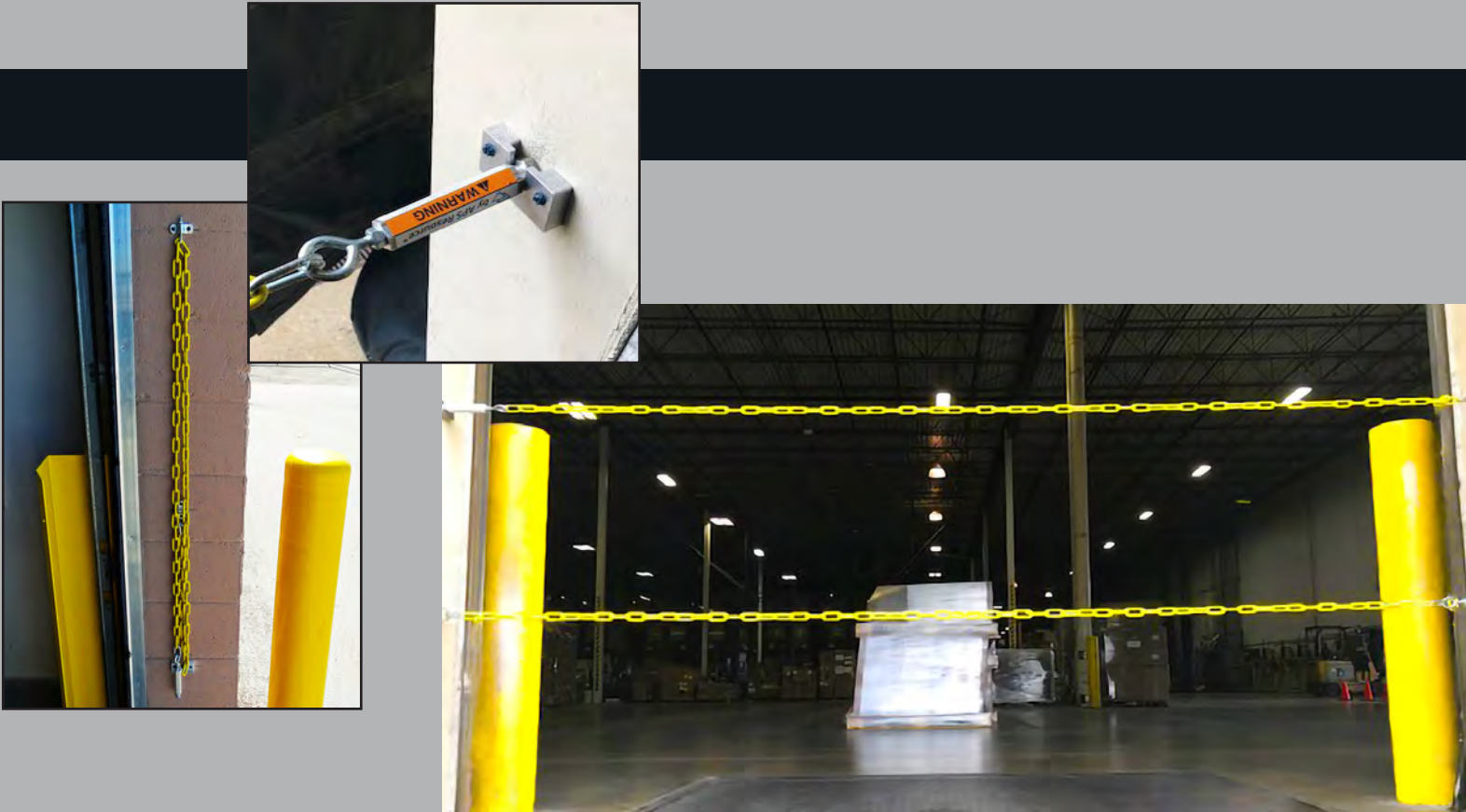

Features:

- High visibility yellow chain
- Unique turnbuckle allows for ease of adjustment
- Chain system top chain meets OSHA standard for withstanding 200 lbs. of force
- Attached to sides of door frame to enhance durability

Benefits:

- OSHA compliant
- Simple manual operation; no electric requirement
- Easy installation
- Install on concrete or metal door jambs
- Sentry Rail option

Door Size
6'
7'
8'
9'
10'

Work Safe Gate™

The Work Safe Gate provides excellent visual protection for personnel.
The easy to operate gate lifts effortlessly out of the opening for complete access.

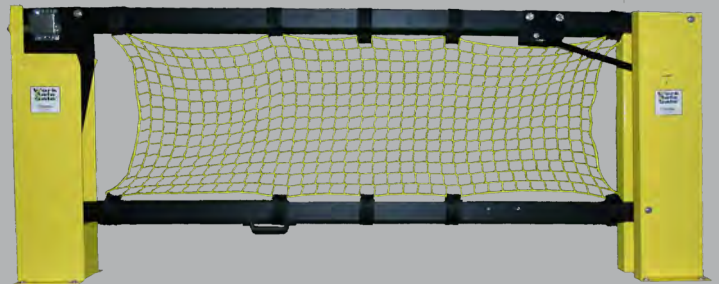

Features:

- 42" top rail
- High visibility yellow with striping on the rails of the non-netted version
- Optional netting and Retrofit Kits available for OSHA compliance

Benefits:

- OSHA compliant
- Safety latch mechanism securely keeps gate closed and can be locked-out with padlock
- Easy operation; no electrical requirements
- Gas spring for easy, one-handed operation

Door Size	Overhead Clearance
6'	10'4"
7'	11'4"
8'	12'4"
9'	13'4"
10'	14'4"

Energy Guard Retrofit Kits

The ENERGY GUARD Retrofit Kit offers top of the line perimeter seal that covers the sides and rear of your dock leveler. The energy-saving solution blocks invasive vermin and insects as well as debris. It can also be used as an extra security measure.

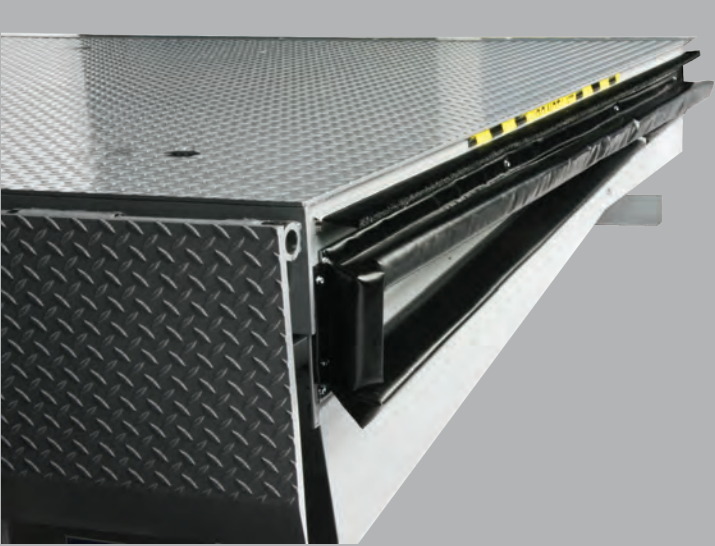

Features:

- Effectively seals off gaps by forming a compression seal around sides and rear of dock leveler
- Side seal assemblies are open cell foam encapsulated with reinforced vinyl
- Effective perimeter seal (sides & back up to 9" above dock)
- Unrestricted access to pit for cleaning and dock leveler inspection
- Retrofit Kits install easily with common tools

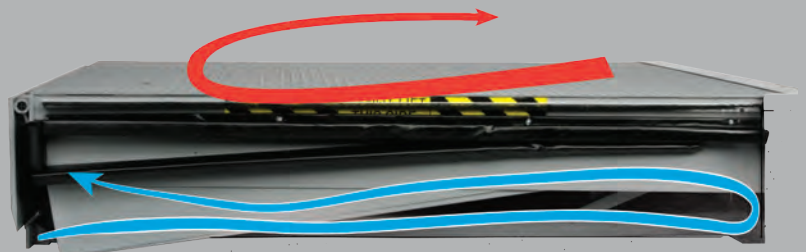

Call APS Resource for an energy calculation and Thermal Analysis!

Dock Leveler Weatherseal

- Tek Screw or weld-on style weatherseal available in nylon brush or PVC
- Nylon brush weatherseal deters rodents and insects from entering around the dock leveler
- PVC flexible weatherseal is resistant to heat and cold, and endures years of use



Chain Sealr™

- Deters rodents and insects from entering the facility through the chain opening of the dock leveler

Rear Hinge Seal

- Available in spiral brush seal, foam cord or foam block styles

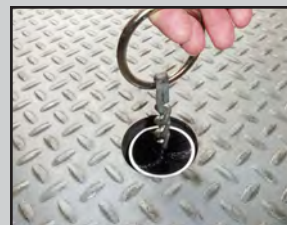

Energy Saving Products

Door Weatherseal

- Available in common door panels widths; 8'2", 9'2", 10'2" and custom sizes
- Available in 1.5", 2" and 3" bristle lengths
- Standard 45° or 180° aluminum extrusion retainers for effective door sealing
- Preferred choice for Food and Pharmaceutical facilities



WeatherWall

The WeatherWall is a unique style of brush weatherseal. The WeatherWall has a sheet of EPDM rubber surrounded by a layer of brush on each side.

- Heavy-duty propylene bristles
- Durable, synthetic EPDM airtight membrane
- WeatherWall can be used anywhere you would normally use brush-style weatherseal - doors, docks, conveyors, etc.
- Available in various sizes
- Brush deters rodents and insects from entering around the dock or doors at Food & Pharmaceutical facilities

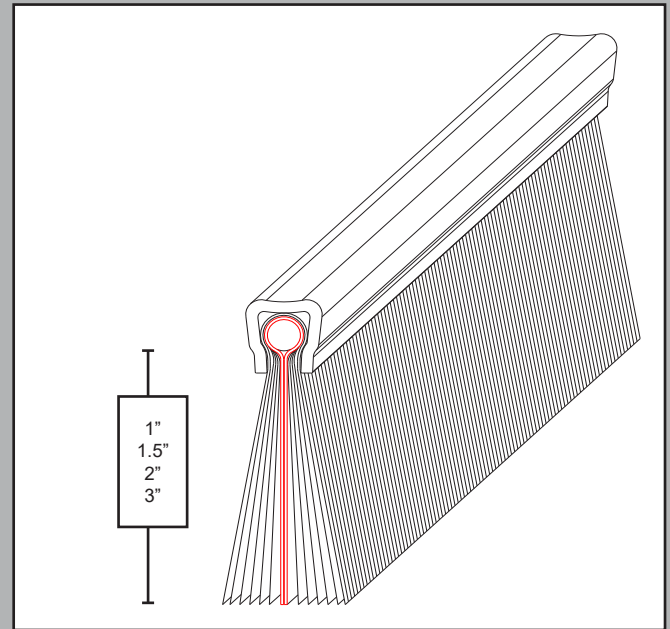

Edge Seal™

- Effectively seals off the bottom of your dock door
- Constructed of 22 oz vinyl; available up to 22' with or without side flaps



Dock Stuf®

- Constructed from heavy-duty coated fabric; designed to eliminate light gaps between lip and bumper

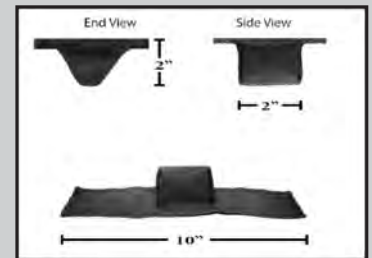

Door Sprag™

- Fills the gap between the dock leveler and pit wall

FLEX-BACK Panel

FLEX-BACK™ Door Panel

The FLEX-BACK Panel is the answer to common lower door panel damage, one of the most frequent and costly maintenance problems in today's busy warehouse.

- Flexible panel construction; durable high impact polymer panel skin
- Handles most common door impact at the dock and helps reduce door maintenance cost
- Standard heavy-duty, easy grip handle
- Provides excellent thermal seal
- Installs easily using standard door hardware
- Available in most popular sectional door sizes from 7' to 12' as well as custom sizes



FLEX-BACK Door Panel flexes upon impact

Security Gates

- Extra-heavy steel construction
- Standard galvanized finish for durability
- Bi-parting security gate is designed to secure dock doors without sacrificing visibility or air circulation
- Available in single-slide and bi-parting in a variety of widths and heights



Single-slide Security Gate



Bi-parting Security Gate

EnviroGate LT

The EnviroGate LT is the economical way to provide security and safety for your facility at a reasonable price. This gate has similar functionality to our standard security gate while still being environmentally friendly.

- Made of 100% recycled, recyclable galvanized steel – provides a lower cost option
- 15 galvanized (0.071" thick) steel
- Non-toxic, water based corrosion – restraint finish
- Solid Steel Casters
- Easy to install; do-it-yourself instructions included
- Optional: standoff bracket & self standing post available



EnviroGate LT

Product Upgrades

LED Light Upgrades for Vehicle Restraints

LED upgrades available for both inside and outside red/green lights. Replace higher maintenance incandescent bulbs with safer, long-lasting LED technology.

- 90% less energy consumed than a traditional incandescent bulb
- No maintenance, extra long lamp life, high vibration resistance
- Available in 12-24V & 115V low-profile design



Inside LED Upgrade



Outside LED Upgrade

ATC - Air Conversion Kit™

The patented ATC (Air Technology Conversion) Kit will extend the life of your old dock leveler and make it more efficient while lowering your operating costs. The ATC Kit converts levelers of most major manufacturers and can be installed easily. The durable airbag lifting module operates without loss of performance in temperatures from -65° to +200°F, even if the bag is punctured.

- No maintenance due to easy push-button operation
- Ergonomic design increases safety and productivity
- Proven technology - tested fully effective at over 200,000 cycles
- Environmentally friendly
- Lowest lifetime ownership cost
- 120V Single Phase



ATC:
Air Conversion Kit

HTC - Hydraulic Conversion Kit™

Fully hydraulic activation in a conversion kit combines ease of operation with low operating costs. Hydraulic main cylinder with hydraulic lip activation makes this kit a complete upgrade for your leveler. Velocity fuse included for emergency safety.

- 1 HP motor/pump assembly
- Hydraulic main cylinder and lip cylinder comes with all necessary hoses, fittings and brackets
- Easy to use, constant pressure push-button control

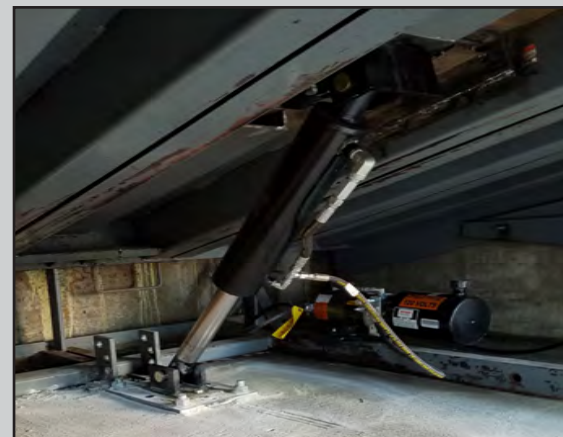

HTC:
Hydraulic Conversion Kit

IMPACT-A-TRACK

LED

The Impact-A-Track LED is designed to protect door tracks in high traffic areas of warehouse against forklifts, pallet jacks and other equipment. It can be relied on to communicate restraint status and deflect impacts while utilizing only a small footprint of your active work area. This product comes packaged in a set of two.

Features:

- LEDs are protected from damage keeping your restraint status visible
- Wrap-around design allows for easy door operation
- Anchors to wall to avoid drilling into floor
- Compatible with photo eyes
- Impact, rust and moisture resistant
- Three phase communication with vehicle restraint
 - Red LED: restraint not engaged
 - Green LED: restraint engaged
 - Amber LED: override



View video

TACTICAL™

LED LIGHT

The Tactical LED Dock Light from APS Resource is a high performing, next generation of loading dock lights. With enhanced technology and high levels of safety additives, this dock light will outperform your expectations. New dimmable and auto ON/OFF features compliment a more compact design that will not disrupt loading dock tasks.



Tactical LED Dock Light	
Output	2,000 Lumens
Input	120VAC 60Hz
Location	Dry Location
Construction	Aluminum
Life	50,000 Hours
Certifications	UL

Features:

- Heavy-duty flexible arm
- Low profile design
- S.W.A.T. built in to light
- Swivel base for easy positioning
- Auto ON/OFF feature
- Single LED
- Dimmable



View video

High Impact LED Dock Light

The High Impact LED™ Dock Light from APS Resource is designed for your most demanding applications at the loading dock. The rugged, cast aluminum housing with polycarbonate lens is engineered to withstand impact at the loading dock without damage to the light. Bright, energy efficient 18 watt LED with 60,000 hour lamp life saves on utility, maintenance and replacement costs. The High Impact LED Dock Light can be easily retrofitted to existing dock arms or can be mounted remotely.



High Impact LED Dock Light

Output	915 Lumens
Power	18 Watt
Input	100-240 VAC, 50/60 HZ
Location	Rated for wet locations, IP66, NEMA 4
Construction	Standard 17" cord with IEC60320-C14 plug
Life	60,000 hours
Certifications	UL and cUL listed, CE certified, RoHs compliant

Features:

- Rugged, compact design for your toughest applications
- Meets requirements for Food and Pharmaceutical facilities
- Durable heavy-duty cast aluminum housing
- Convenient recessed ON/OFF switch
- Optional 6' adapter cord with NEMA 5-15 Plug available

G-Flex Series Dock Light

The G-Flex Dock Light Series from APS Resource is the durable and long lasting answer to your dock light needs. The polycarbonate light head remains cool to the touch and the heavy-duty, flexible, stainless steel arm swivels 180° for easy positioning.

G-Flex LED Dock Light

- 0.12AMP draw @120V
- Steel elbow and swivel base simplify positioning
- Convenient ON/OFF switch
- Meets FDA and USDA requirements for Food and Pharmaceutical facilities
- 3-year limited warranty
- Optional 8" standoff bracket available

G-Flex Dock Light

- Versatile fixture can be used with a separate PAR 30 or Par 38 Lamp, incandescent or LED
- Steel elbow and swivel base simplify positioning
- Convenient ON/OFF switch
- 3-year limited warranty
- Optional 8" standoff bracket available



	G-Flex LED Dock Light	G-Flex Dock Light
Output	803 Lumens	Compatible with more PAR 30 and PAR 38 lamps
Power	14 Watt permanent LED	30 Watts - LED, 150 Watts - incandescent
Input	120V, 50/60 HZ	120V, 50/60 HZ
Location	Dry location only	Dry location only
Construction	Poly light head remains cool to the touch	Poly light head remains cool to the touch
Life	60,000 hours	
Certifications	UL and cUL listed	UL and cUL listed

Dock Lighting

Dock Strobe™

The Dock Strobe will alert all employees to potentially dangerous situations using a 100-candela strobe tube light powered by two 6-volt, lantern batteries.

- Safety yellow casing and amber 360° dome for superior visibility
- Low profile, impact-resistant 4" dome
- Dual 3" heavy-duty industrial grade magnets on base



Reflect & Guide Stripes

The easy to install Reflect & Guide Stripes enhance safety at the dock and throughout the facility.

- Weather resistant for long-term performance
- 47,000 microprisms per square inch provide intense reflective property
- No electrical hook-ups, no bulbs to replace and zero energy use
- 4" Wide; 10", 24", 30" long and custom sizes available



Reflect & Guide Stripe

LED Guide Lights

Guide Lights provide an ideal focal point for drivers, greatly reducing the risk of "overrunning" the dock. The dual Guide Lights illuminate the dock surface exactly where needed to assist a driver in lining up the trailer square to the dock.

- 50,000 hr. LED lamp life
- High-impact polycarbonate construction with ribbed reinforcing
- High visibility from compact illumination on both sides of the door opening
- 120V AC or 12/24 VAC/DC operation; dual light system is standard

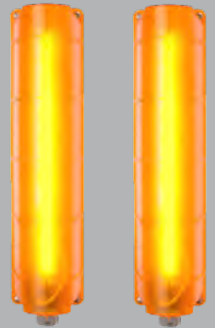

LED Guide Lights

APS&GO-LED™

The APS&GO LED reduces the potential for serious accidents from truck drivers pulling away before loading/unloading is finished.

- High-visibility red/green flashing LED lights with truck driver sign for simple, effective communication
- Compact, low-profile design reduces potential damage and fits between narrow seal/shelter designs
- Impact resistant polymer housing helps prevent corrosion
- Long lasting LED technology for added safety



APS&GO-LED

Dock Lighting

Heavy-Duty Adjustable Fan/Light

The Heavy-Duty Adjustable Fan/Light is durable dock product that enhances visibility and air quality on the loading dock. Attached to an adjustable sliding steel bracket is a hinged dual arm that allows for easy positioning. The product's output qualities makes it an energy conscious solution.

Features:

- No power switches on arm, light or fan; it's to be wired directly to a control panel or separate wall switches
- Spring-loaded pin and handle assembly for ease of adjustable height
- Gas shock assisted adjustable height in one-inch increments (up to 6")
- Dock light: lens conforms to FDA & USDA requirements for facilities
- Dock fan: tapered cone provides focused column of air
- These products carry a (3) year limited warranty



Heavy-Duty Adjustable Fan/Light

E-Saver™ LED Lamps

Size	Watts	Lamp Life	Lumens	Beam Spread
Par 30	13W	25,000 hrs.	800	25°
Par 38	17W		960	

- Energy Star certified
- Both fit most existing dock lights and light fixtures for easy installation
- Meets requirements for Food and Pharmaceutical facilities
- This product carries a (5) year limited warranty with APS Resource



E Saver 30™ LED Lamp



E Saver 38™ LED Lamp

Warehouse Fans

Turbo-ES Fan

The compact Turbo-ES Fan from APS Resource creates a focused column of air that forces hot, cold or musty air from the trailer, replacing it with fresh air. Unlike traditional blade fans that create a broader movement of air, the Turbo-ES fan creates a continuous stream of fresh air that improves the work environment, increasing comfort and productivity. The Turbo-ES Fan's 1275 CFM output provides more airflow at lower amperage than any comparable truck fan on the market!

Features:

- Maximum- 1275 CFM output
- Energy efficient, thermally protected, powerful 1/3 HP, 120V, 3.0 AMP, energy efficient motor
- Easy-grip handle provides convenient adjustment point
- Includes extra long 10' power cord with 3-prong 120V plug
- Increases airflow in and out of trailer for improved comfort
- Protective grill for safety
- Lightweight, compact size
- Thermally protected to prevent overheating
- Dual articulating arm for precise positioning (sold separately)



Dock Light/Fan Combination

Improves poor lighting and ventilation at the dock.

- Heavy-duty, 3-speed, 18", for maximum air movement
- Fan CFM is 3,190 (high), 2,970 (medium), 2,660 (low)
- Available with 24", 42", 62" or 90" total arm reach
- Various light heads and optional energy saving lamps available
- UL listed

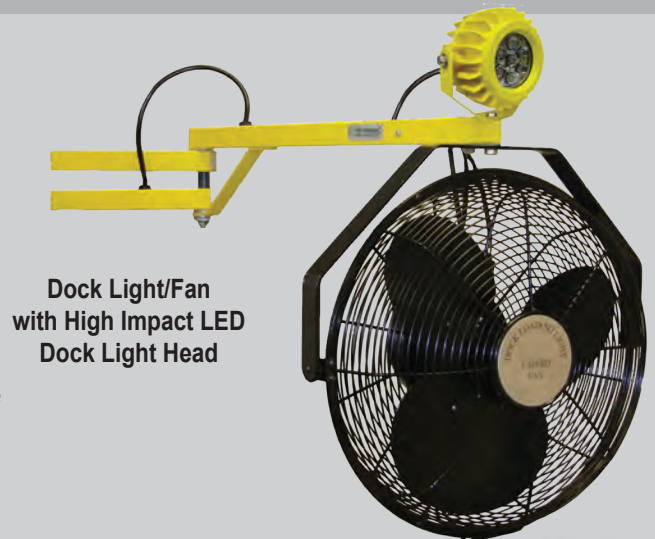

Dock Light/Fan
with High Impact LED
Dock Light Head

Bumpers

Dock Defender

The APS Resource Dock Defender™ bumper is a steel wrapped, laminated bumper built for durability. It can withstand more than 75,000 lbs of pressure and carries a 10 year warranty with APS Resource. With the increased traffic of air-ride trailers and the usage of yard jockeys, the Dock Defender™ is the answer to the abusive loading dock environment.



Molded Bumpers

- Molded in one piece of all new nylon and new polyester reinforced rubber
- Bumper to have a durometer reading of 80 plus or minus 5, tensile strength of 950-1050 PSI, and an impact recovery of 95%



Steel Face Bumpers

- Resilient rubber material of bumpers cut to uniform size with overall projection of 5-1/4" or 6-3/4"; punched to receive 3/4" supporting rods
- Bumper to have 3/8" steel face plate equal to the rubber surface dimensions

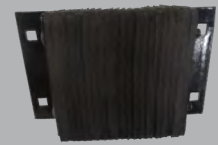

Laminated Bumpers

- Resilient rubber material of bumpers shall be rubberized-fabric truck tires cut to uniform size pads and punched to receive 3/4" supporting rod

Slider Rail™

The Slider Rail™ provides an excellent visual barrier in the workplace. It easily glides open to provide access to protected work areas.

- Effective barrier for protecting personnel working in a hazardous area
- Can be paired with APS Resource Sentry Rail LT
- Easy operation; no electrical requirements
- Latches are closed when not in use
- High visibility yellow powder coated
- Available in 20' (opens 10') & 30' (opens 20') sizes
- 42" top rail meets OSHA standards for withstanding 200 lbs of force from any direction



Slider Rail

Sentry-Rail™

High visibility and structural integrity provide needed protection throughout your facility.



Features:

- Standard posts available in double rail (42" h) and single rail (18" h)
- Posts are 4" square high strength steel with a 5/8" thick baseplate
- Withstands 10,000 lb. load at 5mph
- Optional Swing Gate, Lift-Out Rail and Offset posts available
- Heavy duty steel construction with powder coated yellow for high visibility and lasting durability



Optional Swing Gate



Optional Lift-Out Rail



Sentry-Rail-LT™

High visibility and structural integrity provide needed protection throughout your facility.

- Heavy-duty steel construction with powder coated safety yellow for high visibility and lasting durability
- 42" double rail meets OSHA standard for fall protection systems
- Lift-Out Rail design provides quick and easy access to protected areas
- 8' rail sections can be cut to custom lengths in the field

Impact-A-Track Reflect™

The Impact-A-Track Reflect is a cost-effective protection solution for sectional door tracks. Its design helps keep damage in high traffic areas of the warehouse from forklifts, pallet jacks and other equipment to a minimum.

Features:

- High-visibility, reflective yellow safety strips
- Wrap-around design allows for easy door operation
- Anchors to wall to avoid drilling into the floor
- Compatible with photo eyes
- Impact, rust and moisture resistant
- Can be installed on 2" and 3" track
- 36" length
- Low-profile design does not impede on door opening
- Constructed of Ultra High Molecular Weight Polyethylene (UHMWPE)

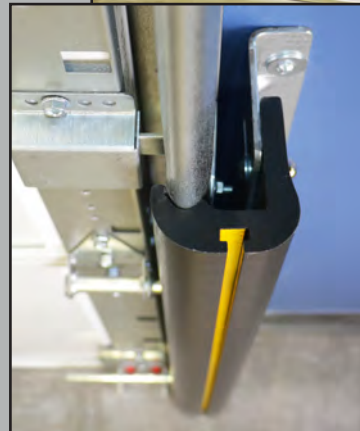

Trak-Sentry™

Trak-Sentry wraps securely around the door's tracks without interfering with normal door operation.

- Heavy-duty steel construction with powder coated safety yellow for high visibility and lasting durability
- Offers maximum protection for your overhead door tracks
- Sold in pairs- available in 3/16" (standard duty) or 1/4" (heavy duty) thick steel
- Standard size 48" and custom templates available



Z-Guard

This compact system takes up less valuable floor space by eliminating the base plate.

- Heavy-duty steel construction with powder coated safety yellow for high visibility and lasting durability
- A cost effective solution to protect your overhead door tracks
- Sold in pairs- available in 3/16" (standard duty) or 1/4" (heavy duty) thick steel
- Standard size 48" or 30" and custom templates available



Column Protectors

Protects I-Beams from forklifts and other equipment. The heavy-duty steel construction completely surrounds I-Beams and absorbs impact. Safety yellow finish is epoxy-based, heat-cured and has a powder coating that's designed to prolong life and durability.

Poly-Barrel Column Protector

- Impact tested to handle a 8,500 lb forklift at 5 mph
- UV inhibitors
- Deflect impact and guard against damage caused by forklifts, hand trucks drum dollies and personnel traffic
- Attach two halves with easy-to-install black straps; no tools required
- 6", 8", 10" or 12" round or square columns, 24" or 42" high
- Optional red coating for fire hydrants



Steel Column Protector

- Powder coated safety yellow finish is epoxy-based and heat-coated to prolong life and durability
- Complete with concrete and assembly hardware
- For 8"-10" I-Beams, 42" high, 150 lbs
- For 12"-14" I-Beams, 42" high, 205 lbs
- Custom sizes available



Fork Sentry

A heavy-duty barrier to protect machinery and personnel from lift truck traffic. Rugged construction barrier provides safety to company assets.

- Heavy-duty, gusseted, 8" high construction
- High visibility safety to machinery, personnel and company assets
- Protects from lift truck and fork damage
- Various sizes available



Rack Protectors

End of Rack Protectors

- Helps protect rack from damage
- Constructed of rugged steel plates
- High visibility safety yellow powder coating
- Available in various heights and lengths



Rack Post Protectors

- Helps reduce potential injury from rack damage
- High visibility safety yellow powder coating
- Sizes: 12", 18", 24" and 36"
- Fits 4" columns, custom sizes available

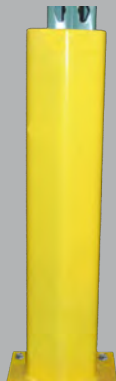

Drain Pipe Protectors

- Heavy-duty steel construction with powder coated safety yellow for high visibility and lasting durability
- A smart investment to eliminate damage to unprotected drain pipes in the busy industrial area
- Two versatile models available: wall mount & I-Beam mount
- Absorbs and dissipates direct impact



Pipe Bollards

- Protection for loading docks, door jambs and other in-plant areas susceptible to a moving vehicle collision
- Available in heavy-duty 6" or 4" pipe
- Powder coated safety yellow for high visibility



Bollard Covers

- Enhance your property's appearance without costly painting or clean-up
- Fit securely over existing bollard posts
- Constructed of 1/8" thick, high density, UV stabilized polyethylene for durability and long life
- OSHA yellow; enhances visibility with red or blue reflective stripes
- Various sizes available



Trailer Stabilizers

OSHA recommends trailer stabilizers to help reduce accidents from trailer-tip and landing gear collapse during loading and unloading, when a tractor does not support the trailer.



Heavy-Duty Trailer Stabilizer

- Static capacity: 100,000 lbs.
- Lifting capacity: 50,000 lbs.
- Two-speed gear box
- Service range: 41-3/4" to 55-1/4"
- Large 16" solid urethane tires



Trailer Jack Heavy-Duty

- Static capacity: 100,000 lbs.
- Lifting capacity: 50,000 lbs.
- Service range: 39-1/2" to 51"
- Two-way reversible hand ratchet
- Heavy-duty 8" semi-pneumatic tires



Medium Duty Trailer Stabilizers

- Static capacity: 100,000 lbs.
- Lifting capacity: 40,000 lbs.
- Service range: 39-1/2" to 51"
- Threaded screw design
- Heavy-duty 8" semi-pneumatic tires



Belted Visual Barrier

- 18 ft. yellow/black 3" stripe for high visibility
- Trak-Sentry with visual barrier 48" high door track protection (optional)



Steel Visual Barrier

- 48" tall x 12' wide
- High visibility yellow/black steel barrier
- lightweight design; additional double-wide (22') wheeled cart design available
- High visible strobe light for added safety (optional)

Wheel Chocks & Chains

OSHA requires trailer wheels to be chocked during loading and unloading if there is no restraint, to prevent trucks from rolling.

3/16" plated coil chain sold separately.

Optional "Truck Must Be Chocked" sign available.

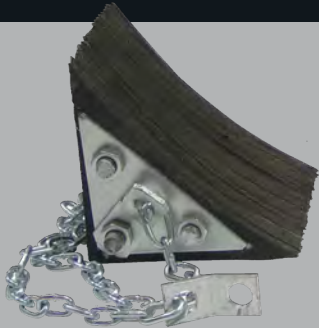

Laminated Wheel Chock

- Extra heavy-duty laminated rubber pads compressed between steel plates
- Contoured to fit tire; reversible

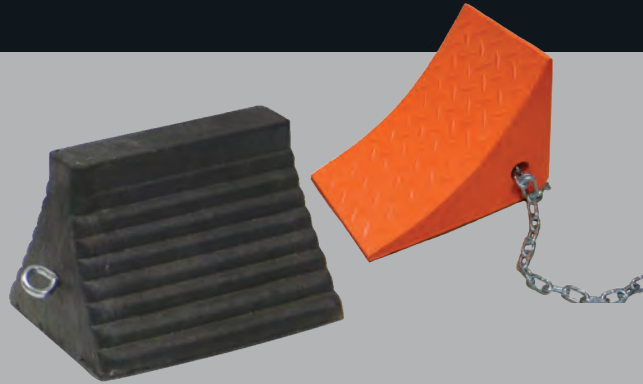

Molded Wheel Chock

- Available in molded rubber or urethane
- Designed to fit both the tire or the pavement
- Available in black or orange



Aluminum Wheel Chock

- Light weight, non-sparking extruded aluminum
- Surface gripping teeth on underside

Wheel Guide

- High visibility safety yellow to stand out in the driveway
- Heavy-duty pipe style guides with dual mounting plates
- Standard size is 8' or 12' in length



Wheel Guide with Flare

- High visibility safety yellow to stand out in the driveway
- Heavy-duty 5-1/2" diameter pipe
- Available in 8', 9', or 10' sizes with 32" flare

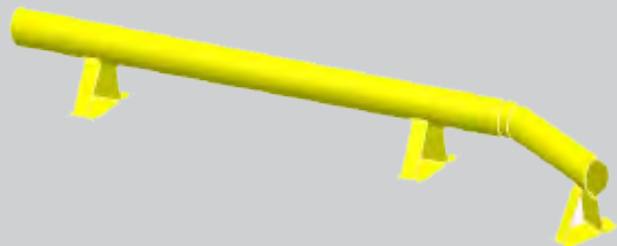

APS RESOURCE'S COMPREHENSIVE LINEUP INCLUDES:

airDefense® Retro Fit Kits
APS&GO - LED™ Safety Light Systems
APS 2000® Rotating Hook Vehicle Restraint
ATC - Air Conversion Kit™
Bollard Covers
Bumper Brackets & Buildouts
Column Protectors
Curb Angle Sets
Dock Bumpers
Dock Defender™ Bumper
Dock Guide Lights
Dock Impact Barrier™
Dock Impact Barrier - LC™
Dock Light / Fan Combinations
Dock Seal Re-covers
Dock Seal Wear Pleats
Dock Strobe™
Dock Stuff®
Dock Visual Barrier
DOK-LOK® Replacement Parts
Door Edge Seal™
Door Section Saver
Door Sprag™ Seals
Drain Pipe Protectors
DUAL CHAIN™
ENERGY GUARD® Retrofit Kits
E-Saver 30™ LED Lamp
E-Saver 38™ LED Lamp
Extra Length Dock Bumpers
FLEX-BACK™ Door Panel
Fork Sentry
G-Flex Dock Light™
G-Flex LED Dock Light™
Heavy-Duty Adjustable Fan/Light
High Impact LED™ Dock Light
Hold-Safe™ Trailer Stabilizer
HTC - Hydraulic Conversion Kit™
Impact-A-Track Reflect
Impact-A-Track LED
Kelley Atlantic Brand Service Parts
Kelley® Brand Service Parts
Laminated Dock Bumpers
LED Guide Lights
LED Upgrade Kits
Metal Head Dock Lights
Molded Dock Bumpers
Pipe Bollards
Pit Kits
Polycarbonate Head Dock Lights
Rack Post Protectors
Rear Spiral Seal
Reflect & Guide Stripes
Rite-Hite® Brand Service Parts
Security Dock Gates
Sentry-Rail™ Guard Railing
Sentry-Rail - LT™ Guard Railing
Serco® Brand Service Parts
Spring Head Dock Lights
Stand-off Kits for Restraints
Steel Faced Dock Bumpers
Steel Pit Kits
S.W.A.T. (Secondary Warning Alert Technology)
Tactical LED Dock Light
Trak-Sentry™ Door Track Protectors
Truck Alert Light Communication Systems
Turbo-ES™ Fan
Visual Barriers
Weatherseal Kits for Dock Levelers & Doors
WeatherWall
Wheel Chocks & Chains
Work Safe Gate™
Z-Guard Door Track Protectors

Your APS Resource Local Distributor Is:

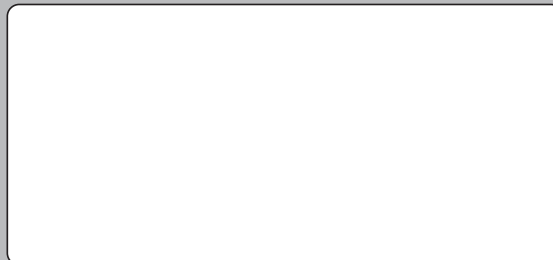

APS Resource reserves the right to change specifications and designs without notice and without incurring obligations. APS products may be the subject of one or more U.S. and/or foreign, issued and/or pending, design and/or utility patents. APS Resource as word and logo are registered trademarks belonging to Entrematic Group AB or other companies controlled by the same organization. All rights reserved.



APS Resource®
Your Aftermarket Solution

**6219 W. Eastwood Ct.
Mequon, WI 53092 USA
(262) 518-1000**